

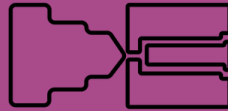

**TECHNI
MODUL
ENGINEERING**

— Composite Alliance Group Member —



SMART INJECTION

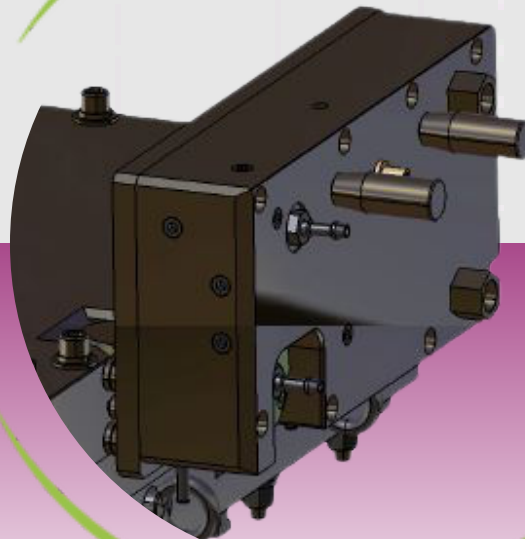

OUR GOAL IS TO BE VISIONARY







To optimize the injection process, Techni-Modul Engineering (TME) has designed an automated and eco-friendly solution for small parts injection : SMART INJECTION. This innovative compact system has a capacity 0 - 30cl, heating 120°C and pressure up to 8 bars.

Our aim is a continuous innovation. With this spirit, we make the world of composite parts manufacturing more efficient and more eco-friendly. Our primary objective is that our knowledge feeds the future.

SMART Injection is a solution to inject resin on dry perform with RTM process without any injection machine. Thanks to this technology, the resin is injected directly to the mold. The quantity used is adapted to the volume of resin required for the part.



Comparison			Conclusion
Labor time	30min	15min	 Save 50% of labor time
Consumables	55€	6€	 Save 89% of consumables costs
Resin wastes	200g	40g	 Reduce wastes by 80%

SOME BENEFITS

- Automated cycle
- Resin : No resin waste in the injection machine and in the injection pipes
- Consumables (injection pipes)
- Save time

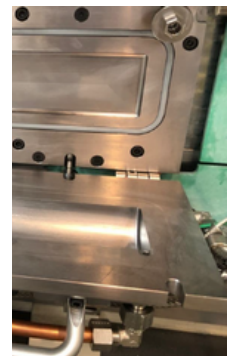

AND OPTIONS

- Injection capacity 0 - 60 cl
- Pressure up to 25 bars
- 1 day remote training
- 100 sets of membranes Inlet/Outlet

SMART Injection is compatible with our presses. Standard Presses engineered for maximum performance in a wide variety of configurations for thermoset process.

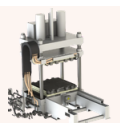

And also with our standard mold for sample plate to complete your lab equipments.

